

DA-9280

Three Needle (Twin Needle) Feed Off
The Arm Double Chain Stitcher

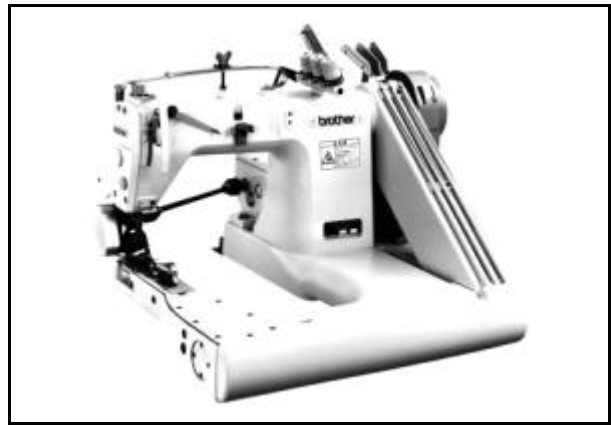

Specifications

Specifications

| | -5 | | -7 | | -C | | -D | |
|-------------------------|--------------------------|--|-------------------------------|---|------------------------------|-----------|--|---|
| Use | Heavy materials | | Extra heavy materials (denim) | | Heavy materials, with puller | | Extra heavy materials (denim), with puller | |
| Puller | No | | | | Yes | | | |
| Sewing speed | 3,600 rpm * 4,000 rpm | | | | 3,600 rpm | | | |
| No. of needles | 2 | 3 | 2 | 3 | 2 | 3 | 2 | 3 |
| Needle (SCHMETZ TV ×5) | #130 | | #140 | | #130 | | #140 | |
| Needle gauge (mm) | 4.8 (3/16) | 5.6 (7/32) 6.4 (1/4) 8.0 (5/16) 9.6 (3/8) | 6.4 (1/4) | 6.4 (1/4) 8.0 (5/16) 9.6 (3/8) | 4.8 (3/16) | 6.4 (1/4) | 6.4 (1/4) | 6.4 (1/4) 8.0 (5/16) 9.6 (3/8) |
| Max. stitch length | 4.2 mm | | | | | | | |
| Needle bar stroke | 35 mm | | | | | | | |
| Height of stepping foot | 11 mm | | | | | | | |
| Feed dog height | 1.2 – 1.5 mm | | | | | | | |
| Min. arm size | 171 mm | | | | | | | |

*3,600 rpm for normal operation

When sewing at a speed of 4,000 rpm, the needle thread cooler (available as an option) should be used.











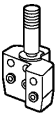

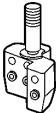
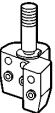
Motor

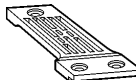
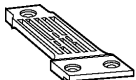
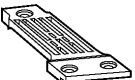
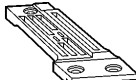
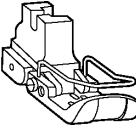
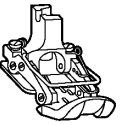
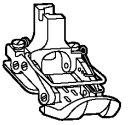
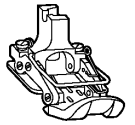
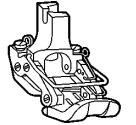
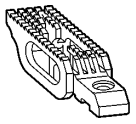
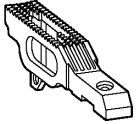
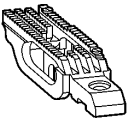
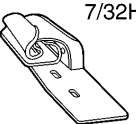
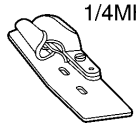
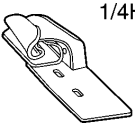
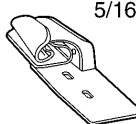
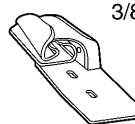
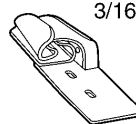
| | |
|--------------|---------------------|
| Power | Motor |
| Single-phase | 2-pole, 400 W motor |
| Three-phase | 2-pole, 400 W motor |









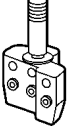
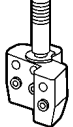
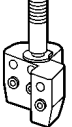

Motor pulley and V-belt (For export)

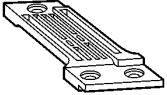
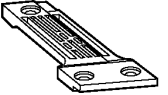
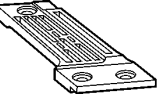
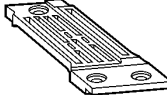
| Pulley O. D. | | 85 | 90 | 95 | 100 | 105 | 110 | 115 | 120 | 125 | 130 |
|-----------------------|------|------|-----|----|------|------|------|-----|-----|------|------|
| Belt size (inches) | | | M45 | → | | M46 | | → | | M47 | |
| | | | | ← | | | | ← | | | → |
| Sewing speed (rpm) | 50Hz | | | | | 3100 | | | | 3600 | 4000 |
| | 60Hz | 3100 | | | 3600 | | 4000 | | | | |

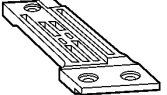
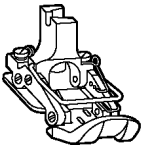
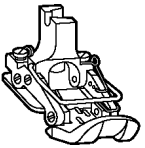
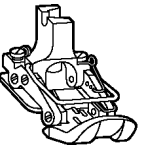
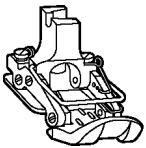
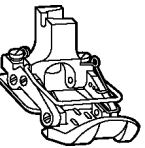
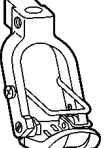
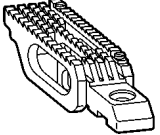
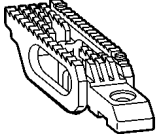
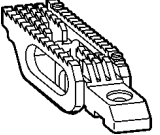
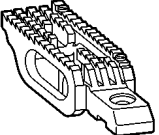
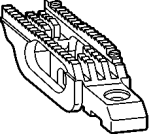
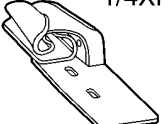
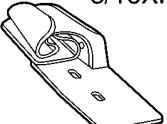
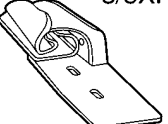
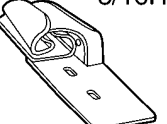





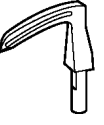



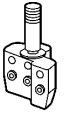

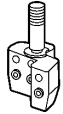
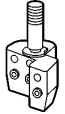
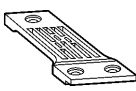
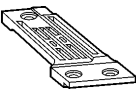
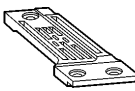
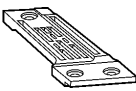
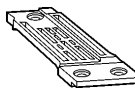
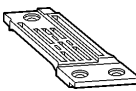

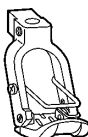
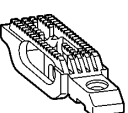
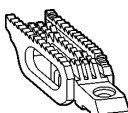
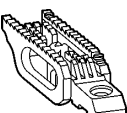

GAUGE PARTS LIST

| Name of part | -5 | | | | | |
|-------------------------|--|--|---|---|---|--|
| | Heavy materials | | | | | |
| | 2.8 mm × 2 [7/64 × 2] | 3.2 mm × 2 [1/8 × 2] | 3.2 mm × 2 [1/8 × 2] | 4.0 mm × 2 [5/32 × 2] | 4.8 mm × 2 [3/16 × 2] | 4.8 mm [3/16] |
| Needle clamp with screw | 183952-001  | 181716-001  | | 181723-001  | 181722-001  | 183954-001  |
| Needle | S43401-021 TV × 5 #130 | | | | | |
| No. of needles | 3 | | | | | 2 |
| Needle plate | S40790-001  | S13042-001  | | S40787-001  | S40783-001  | 159583-001  |
| Presser foot assy | S40788-001  | S40386-001  | | S40785-001  | S40781-001  | 159584-201  |
| Feed dog | S13045-101  | | | S40784-001  | 159588-001  | |
| Lapper assy | 111171-001 7/32H  | 101561-001 1/4MH  | 101564-001 1/4H  | 111177-001 5/16H  | 111183-001 3/8H  | 159609-001 3/16H  |
| Looper (S) | S40375-001  | | | S40395-001  | S40375-001  | |
| Looper (M) | S40376-001  | | | | | / |
| Looper (L) | S40377-001  | | | S40396-001  | S40377-001  | |

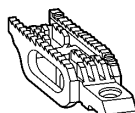
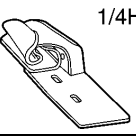
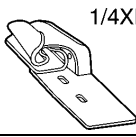
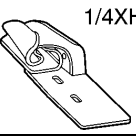
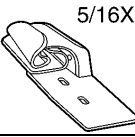
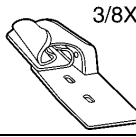
GAUGE PARTS LIST

| -7 | | | | | -C |
|--|---|---|--|--|--|
| Extra heavy materials | | | | | Heavy materials |
| 6.4 mm [1/4] | 3.2 mm × 2 [1/8 × 2] Height difference 1.0 | 3.2 mm × 2 [1/8 × 2] Height difference 1.9 | 4.0 mm × 2 [5/32 × 2] | 4.8 mm × 2 [3/16 × 2] | 4.8 mm [3/16] |
| 183978-001  | 181716-001  | | 181723-001  | 181722-001  | 183954-001  |
| S43401-022 TV × 5 #140 | | | | | S43401-021 TV × 5 #130 |
| 2 | 3 | | | | 2 |
| 147867-001  | S18086-001  | 148864-001  | 148944-001  | 148927-001  | 159614-001  |
| 147868-201  | S18081-201  | 148865-201  | 148945-201  | 148928-201  | 159615-101  |
| 148971-001  | S18084-101  | 148867-101  | 148932-101  | | 159616-001  |
| 147302-001 1/4XH  | | 148951-001 5/16XH  | | 148936-001 3/8XH  | 159609-001 3/16H  |
| S40375-001  | | | S40395-001  | | S40375-001  |
| / | S40376-001  | | | | / |
| S40377-001  | | | S40396-001  | | S40377-001  |

GAUGE PARTS LIST

| Name of part | -C | | -D | | | |
|-------------------------|--|---|---|---|--|---|
| | Heavy materials | | Extra heavy | | | |
| | 3.2 mm × 2 [1/8 × 2] Difference: 0 | 6.4 mm [1/4] | 3.2 mm × 2 [1/8 × 2] Difference: 1.0 | 3.2 mm × 2 [1/8 × 2] Difference: 1.9 | 4.0 mm × 2 [5/32 × 2] | 4.8 mm × 2 [3/16 × 2] |
| Needle clamp with screw | 181716-001  | 183978-001  | | 181723-001  | | 181722-001  |
| Needle | S43401-021 TV × 5 #130 | | S43401-022 TV × 5 #140 | | | |
| No. of needles | 3 | | 2 | 3 | | |
| Needle plate | 156175-001  | 150666-001  | S01634-001  | 150667-001  | 151486-001  | 151478-001  |
| Presser foot assy | 156179-101  | 150668-101  | S01632-101  | 150672-101  | 151487-101  | 151479-101  |
| Feed dog | 156182-101  | 150673-001  | S01635-101  | 150675-101  | 151483-101  | |
| Lapper assy | 101564-001 1/4H  | 147302-001 1/4XH  | 147302-001 1/4XH  | | 148951-001 5/16XH  | 148936-001 3/8XH  |
| Looper (S) | S40375-001  | | | | S40395-001  | |
| Looper (M) | S40376-001  | / | | S40376-001  | | |
| Looper (L) | S40377-001  | | | | S40396-001  | |

OPTION PARTS LIST

Lapper assy

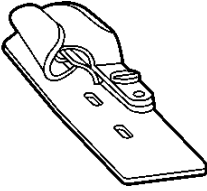
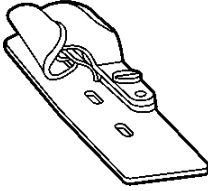
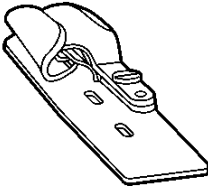
| For medium materials | | |
|--|--|---|
| 111168-001 7/32MH  | 111174-001 5/16MH  | 111180-001 3/8MH  |

Presser foot assy

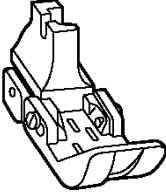
| For heavy materials |
|---|
| S13043-101  |

Optional device

Chain cutter device

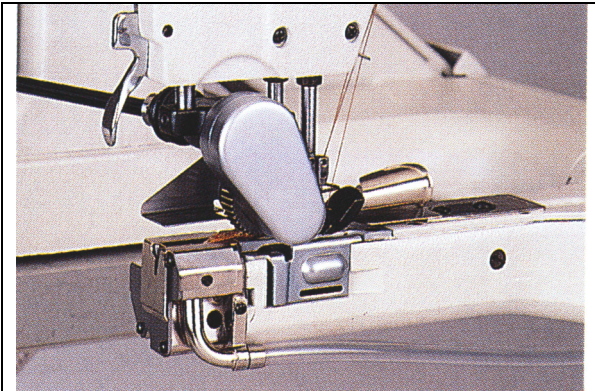

| Part name | Part code | Q'ty |
|---------------------|------------|------|
| For export | | |
| Chain cutter device | S45226-002 | 1 |

*This device can be used for puller device spec. only.

Needle thread cooler

| Needle thread cooler | | |
|-------------------------|------|------------|
| Part name | Q'ty | Code |
| Thread collar tank assy | 1 | S58045-001 |
| Taptite, cup B M3x12 | 2 | 087311-215 |
| Felt | 1 | S08761-100 |
| Thread guide | 1 | S58047-001 |
| Screw, pan SM4.37-40x7 | 2 | 062680-712 |
| Silicone oil | 1 | S06704-001 |